

English



# Argos

Series V.2



**TECHNICAL MANUAL**

 **WARNING!**

Read the following instructions carefully before installing the unit:

? **Take the machine down from the pallet and remove the metal chucks** to place it on the floor before opening and removing the packaging.

? **When discarding packaging material or an old machine**, please consult about recycling.

? **Before connecting to mains**, make sure that the power supply characteristics coincide with those of the machine.

? **The power cable plug** should be installed so the machine can be easily disconnected from mains.

? **If the power cable is damaged**, it should be replaced by the manufacturer or after sales service or similar qualified personnel to prevent hazards.

? **Place a rubber protection** around the power cable in the slot of the lid of the cable winding recess.

? **Do not burn or throw away the battery**. Batteries should be disposed of in accordance with local laws and regulations and can be recycled.

? **Protect the machine** against humidity, dust, dirt, etc. You should particularly avoid any obstruction of the ventilation grilles.

? **Do not clean the machine** with concentrated products as they may attack the paint and alter the colour.

? **Frequent cleaning**, can prevent breakdowns and extend the machine's life.

? **The machine should be installed** in a vertical position, both laterally and back to front, with a maximum inclination of **5% (~2°)**.

? **If you need to replace the power supply cable**, please replace it with the appropriate one for your country:

Argentina, Jofemar code 5500014.

Australia, Jofemar code 5500006.

Spain (STANDARD), Jofemar code 5500000.

UK, Jofemar code 5500011.

Switzerland, Jofemar code 5500004.

USA, Jofemar code 5500010.

**Jofemar S.A.**

Ctra. de Marcilla km. 2, **31350 PERALTA, Navarra, SPAIN.**

http: // [www.jofemar.com](http://www.jofemar.com) Tel. +34 948 75 12 12 Fax +34 948 75 04 20

## TABLE OF CONTENTS

1. Symbols .....	4
2. Operating conditions .....	4
3. Description of components .....	4
3.1. Main technical features .....	5
3.1.1. Door .....	6
3.1.2. Cabinet .....	8
3.2. Volume and weight .....	144
4. Electrical and electronic specifications .....	15
4.1. Initial electrical installation .....	15
4.2. Dispenser motor .....	15
4.3. Display card .....	16
4.4. Control card .....	166
4.5. Expansion card (only for Goya 22/31 and Goya 32) .....	17
4.6. Power support .....	17
4.7. Validator (selector) .....	18
4.8. Compact .....	18
4.9. Electrical drawing .....	19
5. Installation and start-up .....	20
5.1. Installation .....	20
5.2. Start-up .....	20
5.3. Inserting product cards .....	20
5.4. Machine channel restocking .....	21
5.5. Product selection .....	21
5.6. Updating the machine program .....	21
5.7. Machine reset .....	23
5.8. Machine programming mode .....	24
5.8.1. Standby menu without credit (standby status) .....	24
5.8.2. Standby menu with credit (working status) .....	24
5.8.3. Programming menu (programming status) .....	25
5.9. Programming addresses (Main Menu) .....	26
6 Troubleshooting .....	48
7. Annexes .....	51
7.1. Transport feet and adjustable levelling feet .....	51
7.2. Removing the product outlet collector .....	51
7.3. Vandal protection (Optional) .....	51
7.4. Minor remote control configuration .....	52
7.5. Peripherals .....	53
8. Cleaning and Maintenance .....	56
9. Recycling .....	56
10. Environment .....	57
11. Regulations .....	57

## 1. Symbols

 This symbol means there are more detailed explanations on this subject elsewhere in the manual.

 This symbol means that the text in question refers to programming.

 This symbol indicates very important information.

 This symbol is a warning of high voltage hazard.

 This symbol indicates that a given material **should not be disposed of as domestic waste**.

 This symbol indicates that a given material is **recyclable**.

 This symbol indicates that **Jofemar** is committed to the **environment**.

## 2. Operating conditions

This machine has been specifically designed to work in interiors. The machine leaves the factory adjusted to work properly at an ambient temperature between **5 °C and 32 °C** (41 °F and 89.6 °F) with a maximum humidity of **60%**.

## 3. Description of components

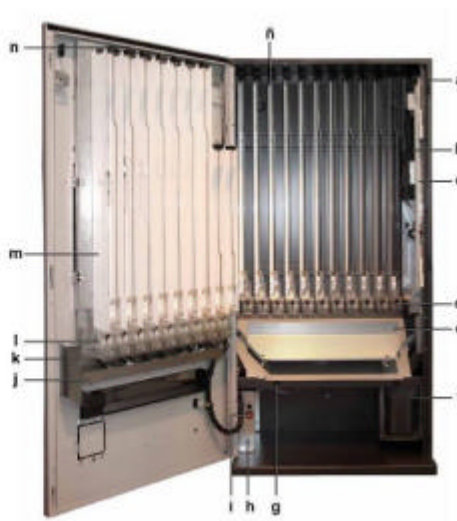
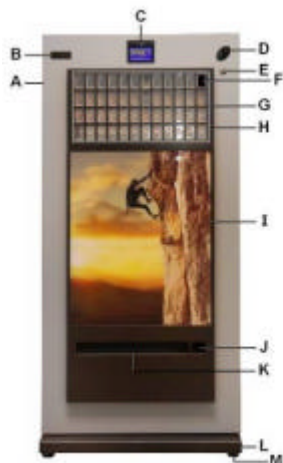

Position	Description	Position	Description
A	Door	a	Cabinet
B	Banknote reader (opt.)	b	Compact
C	Display	c	Compact support
D	Coin slot	d	Cabinet dispensers
E	Upper lock	E	Cabinet collector
F	Coin return pushbutton	f	Vault location
G	Product selection buttons	g	RS-232 connection
H	Cabinet cover	h	Power assembly
I	Advertising panel	i	Main switch
J	Coin outlet	j	Door deflector
K	Product delivery opening	k	Coin exit guide
L	Cabinet base	l	Door dispensers
M	Adjustable levelling feet	m	Door channels
		n	Programming pushbutton
		ñ	Cabinet channels

### 3.1. Main technical features

- ? Dispenses a large range of packets.
- ? Pre-cut partitions to house a banknote or card reader.
- ? Flexible configuration and programming, up to 41 channels.
- ? FIFO product delivery system alternating dispensing from different channels if they are linked via programming.
- ? Large animated LCD display with direct status and programming messages.
- ? Telemetry-ready, including remote reading of audits, sales, incidents and changes in programming options.
- ? Sales accounting and control, as well as data output via RS-232-C. The machine can also be programmed via a **Jofemar** electronic terminal.
- ? Continuous operational self-testing
- ? LED-backlit product delivery and coin return recess, advertising panel and product selection buttons.
- ? Independent locks: advertising panel, product selection buttons and door.
- ? Easy access for changing advertising panel and product cards .
- ? The metal parts are constructed in 1.5 mm (1/17") thick galvanised steel, with rustproof protection and an external coat of rustproof paint.

### 3.1.1. Door

On the front of the door you can see: the advertising panel , the display, the coin slot, the product selection buttons, the coin return button, the upper lock, the lower lock and the product delivery and coin return recess. On the back of the door you can see: the programming button, the door channels, the door dispensers, the door deflector and the door funnel (for machines that include this feature).

A banknote reader (optional) and a card reader (optional) can be adapted.

#### Advertising panel

The panel is used to customise the machine's aspect. It can be customised with any motif.

It is made of polycarbonate. Supported by a metal frame and backlit with LEDs.

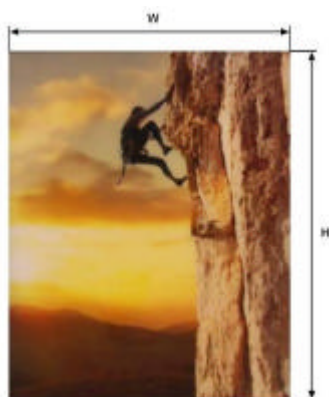

Fig. 01

ARGOS Model	Dimensions		
	Height (H)	Width (W)	Thickness (F)
10	491 mm. (19 1/3")	246.5 mm. (9 2/3")	3 mm. (1/8")
11	695 mm. (27 1/3")	302 mm. (12")	3 mm. (1/8")
11/14	695 mm. (27 1/3")	302 mm. (12")	3 mm. (1/8")
15	695 mm. (27 1/3")	391 mm. (15 1/2")	3 mm. (1/8")
15/20	695 mm. (27 1/3")	391 mm. (15 1/2")	3 mm. (1/8")
21	695 mm. (27 1/3")	576 mm. (22 3/4")	3 mm. (1/8")
21/29	695 mm. (27 1/3")	576 mm. (22 3/4")	3 mm. (1/8")

#### Lighting

The lighting systems light up the advertising panel, the product selection buttons and the product delivery and coin return recess.

The lighting system is an LED-based system that includes the following two features: Uniform lighting and minimal power consumption.



Fig. 02

### **i** Display

The display shows the drop-down menus and is used in machine programming operations, displaying audit data and technical incidents, as well as displaying available credit and product sale prices.

? It can also reproduce animations.

Dimensions	Height	Width
INTERIOR	45 mm (1 7/9")	84 mm (3 1/3")
EXTERIOR	53 mm (2")	92 mm (3 5/8")

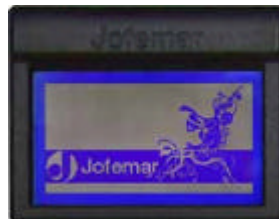

Fig. 03

### Coin slot

This is a standard coin slot made from Zamak.

### **i** Product selection pushbutton panel

The pushbutton panel consists of pushbuttons (**S**) for direct, easy access to the different products (depending on the machine model, there will be more or fewer selections).

The coin return button (**R**) located at the top right is used to recover coins that have been inserted (if the user wishes to recover the amount that has previously been inserted).

The six pushbuttons identified as **?**, **?**, **?**, **?**, **A** and **C** are used for product selection but also for programming and machine configuration purposes, and for the numbered buttons (**N**) 1, 2, 3, 4, 5, 6, 7, 8, 9 y 0, used for entering prices (Fig. 04).

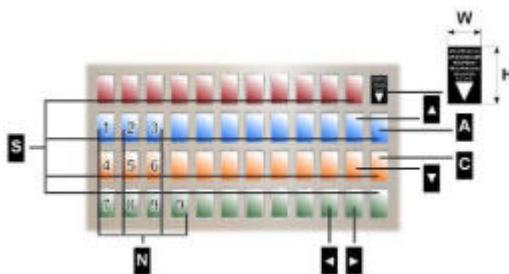

Fig. 04

Label dimensions.		
Height (H)	Width (W)	Thickness (F)
50 mm (2")	30 mm (1 1/6")	0,8 mm (1/32")

### Button identification

The pushbuttons are the main part of the machine. The following pictures identify each model, with the numbering order as shown below .

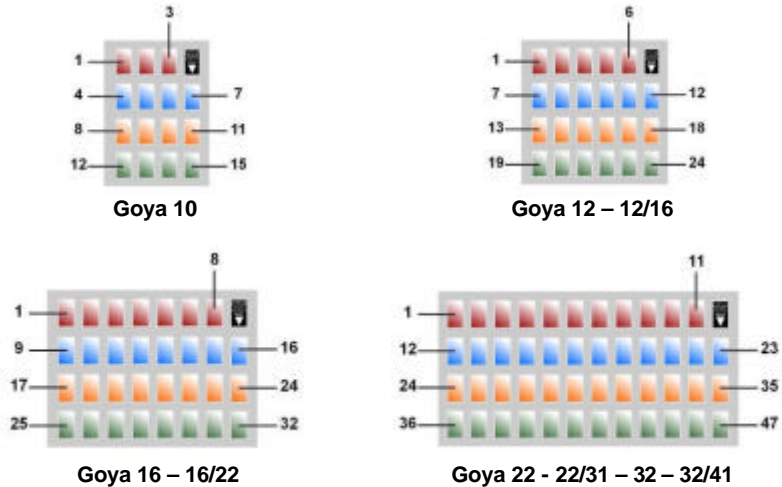

Fig. 05

**Locks**

The upper lock opens the door of the machine and it has a plate and three vandal-proof anchor points.

**Programming pushbutton**

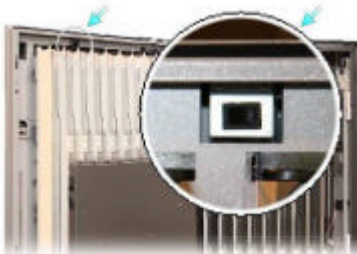

Fig. 06

It is located at the back of the door above the channels, (see fig. 06), and it is used to access all programming options: sale prices, messages to be shown on the display, resets, etc.

**Note:** The machine door must be kept **open** to access programming.

**3.1.2. Cabinet**

The cabinet contains the following: the cabinet channels, the cabinet dispensers, the compact support, the vault, the product outlet collector, the power assembly and the open door safety switch. The Goya 32 and 32/41 models include intermediate channels (optional)

### Product delivery collector

El Product delivery collector is the last component to receive the product before it is removed by the user from the product delivery recess.

It also serves as protective lid for the control and extension cards and it is fixed to the cabinet with two screws (see fig. 07).

The material used for this assembly is 0.8 mm (1/32") gauge galvanised plate.



Fig. 07

### Vault



Access to the vault is through the lid, which is equipped with a lock.  
The standard vault has a large capacity (4.5 litres).

? There is a self-blocking security option available for this type of vault.

Fig. 08

### Electronic control system

It consist of several printed circuit cards:

- **Control card**, which governs all of the machine's movements, as well as programming of options and product audits, and also power sources that supply appropriate voltages for logic control, to move the channel motors, to supply peripherals on bus 485 and to supply the product detection system. The program is recorded in FLASH memory.
- **Expansion card**, which is supplied and controlled by the control card and connects the dispenser motors. It is included in the Goya 22 and 31/32 models
- **Display card**, which contains the LCD display, the buzzer control and connections for the product selection keypad and programming button. This is a peripheral unit controlled by the control card with which it communicates using the 485 bus. The display can show animations.

### Compact

- **Coin changer** (see full manual of the X-10 compact).

- Communications between machine and compact take place under an **X-10** protocol. The machine behaves as master unit while the compact acts as slave unit.

In single sales mode only the coins or banknotes (if it has a banknote reader) whose value can be returned will be accepted and the maximum credit that we can enter can never exceed the maximum recovery.

Additionally, maximum recovery is updated automatically with the highest price in case such price exceeds the value of maximum recovery.

To ensure proper machine operation you should check that maximum return and prices are properly programmed. In single sale mode you need to insert money until you reach or surpass the price of the desired product. When you enter the product selection from the keyboard, the display shows the price of the product. If this price is less than or equal to the money inserted, if the machine is not out of that product and if there is enough change, the sale is allowed.



Fig. 09

Dimensions	Weight
353 x 137 x 82 mm 13 8/9" x 5 2/5" x 3 2/9"	2.8 kg 6 lb

**i Selector**

- **Selector** (see T-15 selector manual).



Fig. 10

The coin selector is a premium validation device that can recognise up to 24 different coins or tokens. It has a coin separator coil that allows it to accept or reject coins.

**COIN OR TOKEN CHARACTERISTICS**

Thickness range	Diameter range
1 mm to 3.2 mm 2/51" to 1/8"	16 mm to 32 mm 5/8" to 1 1/4"

### Machine configurations

The **Argos Series** can have up to 29 channels, depending on configuration. The following table shows the various possible configurations with the different types of channels available.

Argos Series	Product selection buttons	CANALES				
		Door	Cabinet	Single	Multiple	Total
10	15	0	10	4	6	10
11	23	4	7	11	0	11
11/14	23	7	7	8	6	14
15	31	6	9	15	0	15
15/20	31	11	9	10	10	20
21	47	9	12	21	0	21
21/29	47	17	12	13	16	29

Argos 10

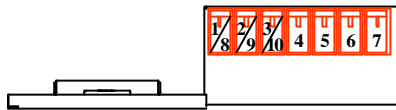

Argos 11

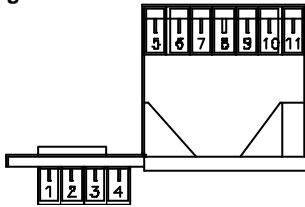

Argos 11/14

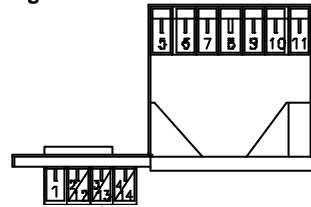

Argos 15

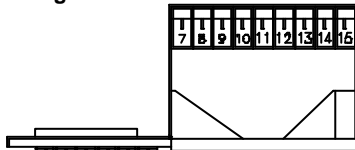

Argos 15/20

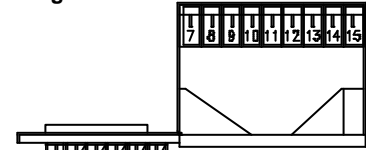

Argos 21

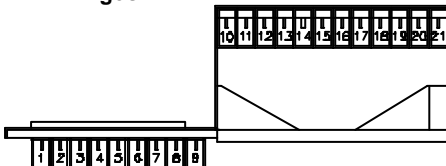

Argos 21/29

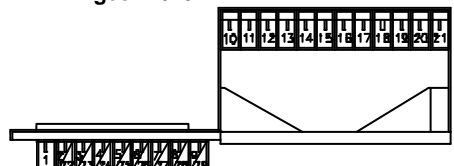

**CHANNEL POSITIONS**

- A. Single door channels
- B. Multiple door channels
- C. Cabinet channels

**Note:** The multiple configuration system can be adapted to every machine in the Argos series. This system is adaptable to all door channels, except the first one.



Fig. 11

**Partitions**

The partitions are the part of the machine used to make up the channels where the product is stored.

The material used is 0.8 mm (1/32") gauge plate painted white.

- A. Door partition
- B. Multiple partition
- C. Cabinet partition

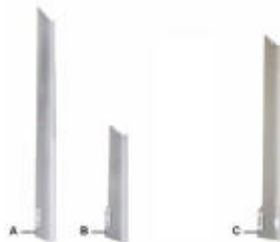

Fig. 12

? The number of partitions and their distribution varies depending on the machine series and configuration.

? Some partitions are already pre-cut (see fig. 13) so one can include peripherals, such as a banknote reader and a card reader.



Fig. 13

**Capacity per channel**

The following table shows packet capacity in terms of channel type.

Argos Series	Packet capacity						
	Door	38	Múltiple	17	Cabinet	40	Total
11	152		0		280		432
11/14	38		102		280		420
15	228		0		360		588
15/20	38		170		360		568
21	342		0		480		822
21/29	38		272		480		790
ARGOS 10	Cabinet	31	Bottom múltiple	10	Upper múltiple	20	Total
		124		30		60	214

**Catches**

The catches depend on the type of product to be dispensed. If standard packets are sold, fixed catches are used and if other packet sizes are sold, variable catches are used. Variable catches are normally used in the cabinet channels, except for the last two channels, because of the space required for the compact support.

**Fixed catch**



**Fig. 14**

**Variable catch**



**Fig. 15**

**PRODUCT DIMENSIONS WITH STANDARD CATCH**

FORMAT	Thickness (F)	Width (W)	Length (H)
<b>Standard</b>	19-25 mm 3/4"-1"	52-60 mm 2"-2 1/3"	83-89 mm 3 1/4"-3 1/2"

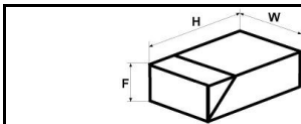

**NOTE:** For other types of products or special sizes please contact your **Jofemar** distributor.

**POSITION OF VARIABLE CATCHES DEPENDING ON PRODUCT FORMAT**

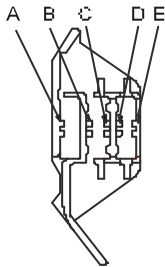

**Fig. 16**

		THICKNESS				
		17-20 mm 2/3"-4/5"	19-25 mm 3/4"-1"	26-32 mm 1"-1 1/4"	30-34 mm 1 1/6"-1 1/3"	34-38.5 mm 1 1/3"-1 1/2"
<b>L E N G T H</b>	97-104 mm 3 5/6"-4"		2A			
	88-94 mm 3 1/2"-3 5/7"	2B-2C	3C		5C	
	83-88 mm 3 1/4"-3 1/2"	2C	3C	5C		5B
	78-83 mm 3"-3 1/4"					
	71-78 mm 2 4/5"-3"	2D	2E			

### Anchoring

These machines are fitted with holes that can be used to anchor the machine to the wall, if necessary. An optional anchoring kit is required for this (only for Goya 10).

### 3.2. Volume and weight

Argos Series	Height (H)	Width (W)	Depth (F)	Weight
<b>10</b>	1045 mm. 41"	478 mm. 18 5/6"	300 mm. 11 3/4"	000 kg. 000 lb.
<b>11</b>	1.600 mm. 20 1/2"	478 mm. 18 5/6"	415 mm. 16 1/3"	86,4 kg. 000 lb.
<b>11/14</b>	1.600 mm. 20 1/2"	478 mm. 18 5/6"	415 mm. 16 1/3"	000 kg. 000 lb.
<b>15</b>	1.600 mm. 20 1/2"	600 mm. 23 5/8"	415 mm. 16 1/3"	104,2 kg. 000 lb.
<b>15/20</b>	1.600 mm. 20 1/2"	600 mm. 23 5/8"	415 mm. 16 1/3"	000 kg. 000 lb.
<b>21</b>	1.600 mm. 20 1/2"	785 mm. 31"	415 mm. 16 1/3"	118 kg. 000 lb.
<b>21/29</b>	1.600 mm. 20 1/2"	785 mm. 31"	415 mm. 16 1/3"	000 kg. 000 lb.



Fig. 17

#### 4. Electrical and electronic specifications\_

The transformer and source are supplied directly with mains voltage (220 Vac).

**IMPORTANT!** None of these should be worked upon without unplugging the machine from mains.

Goya Series	Power supply voltage	Maximum power consumption	Maximum amperage
10	220 ± 10% VAC	30 W	0.20 A
12			
12/16	110 ± 10% VAC	30 W	0.40 A
16	220 ± 10% VAC	40 W	0.25 A
16/22			
22			
22/31			
32	110 ± 10% VAC	40 W	0.50 A
32/41			

#### 4.1. Initial electrical installation ✎

Prepare a 220-240 Vac, 50 Hz and 3 A (110-125 Vac, 60 Hz and 3 A), socket, protected with an automatic connection system. Prepare a 220-240 Vac, 50 Hz and 10 A (110-125 Vac, 60 Hz and 15 A), socket, protected with an automatic connection system. The socket should match the machine plug (Schuko with earth connection). Follow all Low Voltage Installation Regulations and check that ground connection works properly once the machine has been installed.

#### 4.2. Dispenser motor

The dispenser motor dispenses the product. The same motor is used for all channels. It uses a 12 Vdc power supply.

The first product detection microswitch checks whether there is product or not and tells the machine.

The second microswitch determines the dispensing position of the motor.

As an option, there is a dispensing motor with a paddle with catches for narrower products.



Fig. 18

### 4.3. Display card

The display tells the control card what keys have been pressed, showing messages on screen and issuing the beeps sent by the control card.

#### DISPLAY CARD CONNECTORS

A. LCD connection
B. RS-485 Communication
C. RS-485 communication
D. USB Connector
E. Selection jumper
F. Programming pushbutton harness
G. Inputs / Outputs
H. Recovery line
I. Keypad membrane.
J. Micro-controller programming

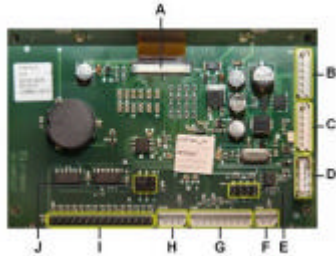

Fig. 19

### 4.4. Control card

Communications with the compact and with the peripherals takes place under different protocols.

#### CONTROL CARD CONNECTORS

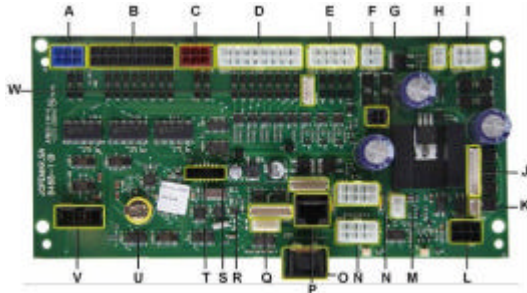

Fig. 20

A. Dispenser connector	M. LCD bottom connection
B. Dispenser connector	N. Internal RS-485 communication
C. Dispenser connector	N. Internal RS-485 communication
D. Dispenser connector	O. RS-232 communication (1)
E. Dispenser connector	P. External RS-485 communication
F. Lighting output	Q. RS-232 communication (1)
G. Expansion card power supply	R. RS-232 communication (2)
H. Lighting input	S. External RS-485 communication
I. Transformer connection	T. Micro-controller programming
J. Executive connection	U. Battery
K. Door microswitch	V. Expansion card communication
L. MDB connection	W. External recovery motor

#### 4.5. Expansion card (only for Goya 22/31 and Goya 32)

Communications with the control card and with the peripherals take place under different protocols.

##### EXPANSION CARD CONNECTORS

A. Dispenser harness
B. Dispenser harness
C. Dispenser harness
D. Dispenser harness
E. Dispenser harness
F. Master power supply
G. Master communication

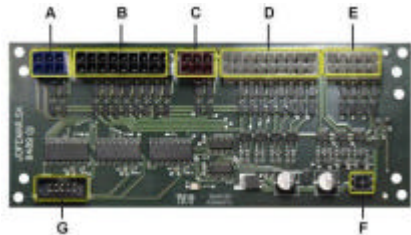

Fig. 21

#### 4.6. Power support

The power support is located on the right-hand side at the bottom of the cabinet and includes the components shown in fig. 22. To remove the assembly from its location, remove the two screws that hold it attached to the bottom of the cabinet and the two screws that fix the support to the base of the cabinet.

A. Connection hose
B. Power assy. support
C. Filter
D. 3 A electric system protection fuse
E. Main switch
F. Control card connection
G. Power source
H. Transformer

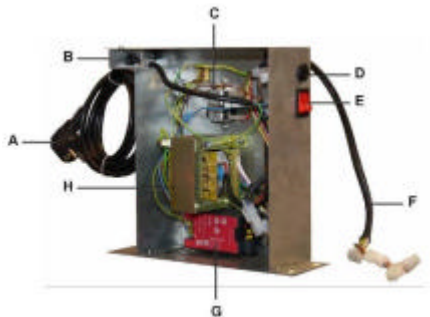

Fig. 22

##### POWER SUPPORT ASSEMBLY COMPONENT CHARACTERISTICS

<b>Main switch</b>	Bipolar
<b>EMI Filter</b>	3 A
<b>Transformer power rating</b>	100 W
<b>Transformer primary</b>	230 Vac   110 Vac
<b>Transformer secondary</b>	24 Vac, 15 Vac, 11 Vac
<b>220 Vac network protection fuse</b>	3 A
<b>110 Vac network protection fuse</b>	

#### 4.7. Validator (selector)



Its is supplied with 12 Vdc through a cable connected to the control card of the compact

<b>A.</b> Coin inlet
<b>B.</b> Rejected coins
<b>C.</b> Accepted coins
<b>D.</b> Switches
<b>E.</b> 4-way recording connector
<b>F.</b> CCTALK connector (optional)
<b>G.</b> Main 10-way connector

Fig. 23

#### 4.8. Compact

Power consumption in standby	Maximum current peak	Power supply voltage
≈ 150 mA	4 A	DC ⇒ 12V

The validation unit is an integrated electronic coin validator and return system for automatic vending machines with 485 communications protocol. Its water-resistant protection system allows for seamless performance in adverse environments.

<b>A.</b> U-shaped plate
<b>B.</b> Recovery motor control
<b>C.</b> Photocells
<b>D.</b> Change tubes
<b>E.</b> Return carriage
<b>F.</b> External tube connection harness
<b>G.</b> 485 connection harness
<b>H.</b> Coin separator
<b>I.</b> Selector connection harness

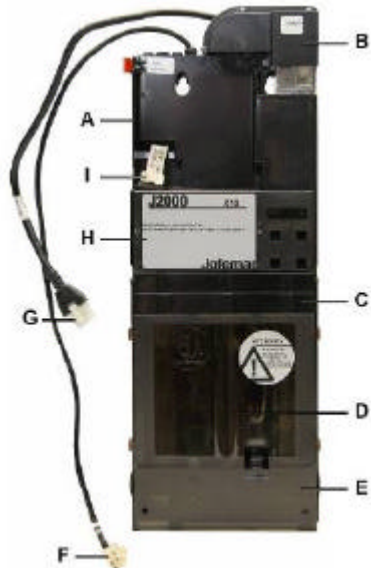
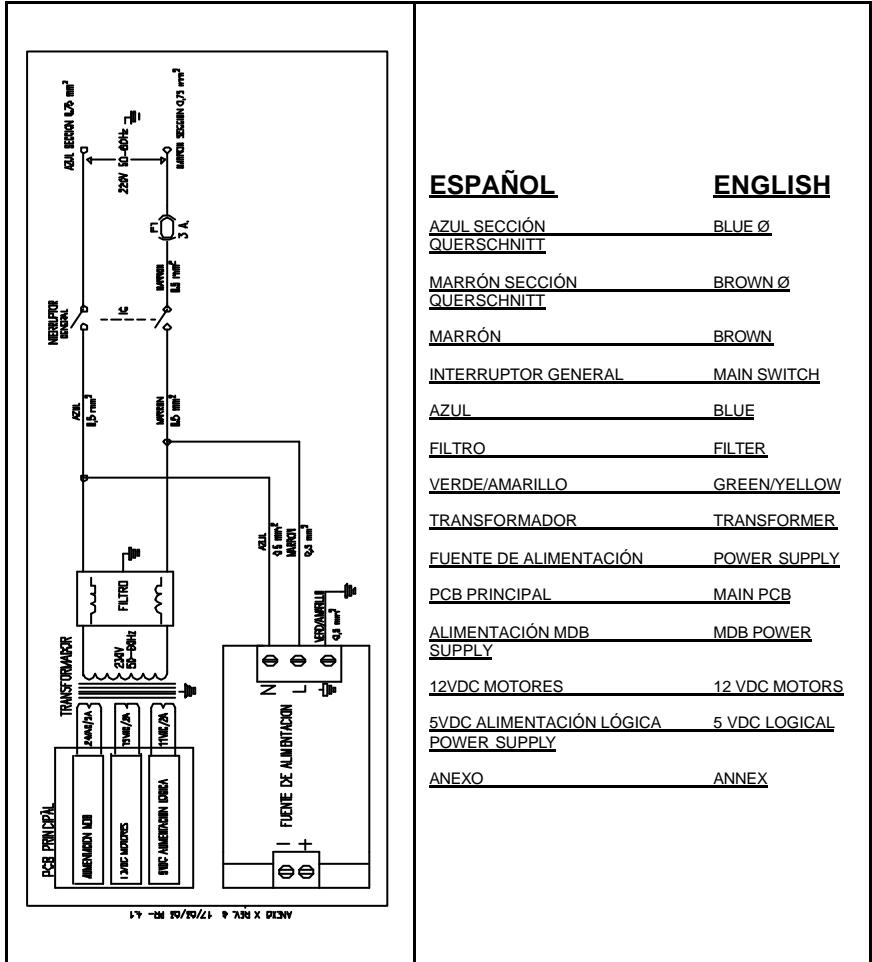

Fig. 24

## 4.9. Electrical drawing



## 5. Installation and start-up

### 5.1. Installation

Do not install the machine near active heat sources (heaters, radiators, etc.). Leave a distance of at least 7 centimetres between the back of machine and the wall or other items.

**IMPORTANT:** It is important for the machine to be level, as it should operate in a vertical position, both laterally and back to front, located so the mains plug is accessible and with a maximum inclination of 5% ( $\sim 2^\circ$ ).

### 5.2. Start-up

**VERY IMPORTANT:** To ensure the machine works properly it is essential that the first reloading of the compact should be carried out through ① address 25 (see compact manual), a minimum three coins should be loaded in each tube, as indicated in this manual.

Every time the machine is connected to mains, it carries out an internal test, during which the display will show the following messages.

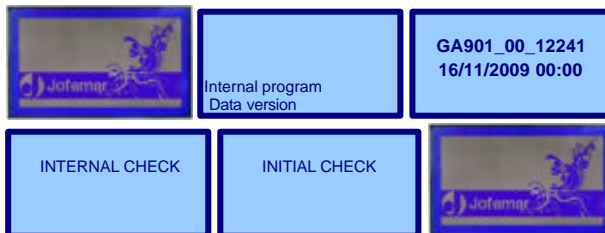

### 5.3. Inserting product cards

Open the upper cover to insert the cards for the products to be sold (see dimensions in fig. 04).

Insert the cards by sliding them along the guides from the top opening downwards (see fig. 25).

After completing the panel, close the upper cover.



Fig. 25

## 5.4. Machine channel restocking

Open the machine door and restock all the products frontally, ensuring that no packet ends up in reverse position.

If necessary, push the channel rod slightly towards the left (see fig. 26).



Fig. 26

## 5.5. Product selection

To select a product press the button for that product.

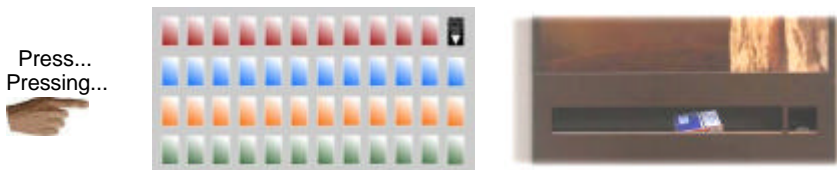

Fig. 27

You can program all product selection buttons and the channels associated to them. Detection of existing channels occurs when the machine is turned on and when you exit programming mode. If the channel is not present in the machine, we cannot select it to do any kind of vending or programming operation with it.

If coins have not been inserted and you select a product, the price will appear on the display. If the price is set to zero, the program will not carry out any operation with this product.

## 5.6. Updating the machine program

The control card of the machine has been designed to use flash technology. This allows you to update the program in the card without needing to remove any part of the machine, as this task can be done through a 180 degree 5 pin DIN connector in the RS-232 port. Program updating can be done through a PC or a J-120 reprogramming card drive.

### ! USING A PC

#### Follow these steps to update the program:

1. With the machine turned off, connect the PC to the machine using the RS232 cable.
2. Choose the program to install in flash memory:
  - The program files should be stored in the subdirectory of the hard drive corresponding to the GOYA machine.



- Run the PC program. Choose the menu option FLASH – RECORD - GOYA and choose the .BIN file to record.
3. Turn the machine on.
  4. When the program has been updated, a message will appear on the PC screen indicating that the flash memory has been successfully recorded.

## **! USING THE J-120 REPROGRAMMING CARD DRIVE**

### **Follow these steps to update the program:**

1. Insert the reprogramming card in the desktop card drive, which should be turned on.
2. Choose the flash recording application:
  - The program files should be stored in the subdirectory of the hard drive corresponding to the GOYA machine.
  - Run the PC program. Choose the menu option CARD – RECORD - GOYA and choose the .BIN file to record.
3. Once the card has been recorded, take it out of the desktop card drive and insert it in the reprogramming card drive.
4. With the machine turned off, connect the card drive using the machine's 180°, 5-pin DIN connector.
5. Turn the machine on. First, the card drive's green LED will light up and then, while the program is being recorded, the red LED and the green LED will blink.
6. When the program has been updated, the card drive's green LED will blink. At this point you can disconnect the card drive from the machine.

## **! ⓘ USING THE EASYFLASH REPROGRAMMING DEVICE**

### **Follow these steps to update the program:**

1. With the machine turned off, connect the EASYFLASH device to the machine using any of the cables supplied.
2. As soon as the program is loaded, it will load the data from the file TYPES.DAT for the machines with which you wish to communicate.
3. The first thing the program requests is the type of operation you wish to carry out.
  - **Recording a program in flash memory.**
  - Erasing the card's flash memory.
  - Identifying the program recorded in a card.
4. After choosing the operation, you have to select the machine with which you wish to communicate.
5. You need to select the file you are going to record.
  - The program can work with two standard reference file formats, .HEX (Intel) and .BIN. When the program has more than one bank, the file extensions will be .H00, .H01, .H02 ... (or .B00, .B01, .B02 ...) and so on until all banks are completed. In these cases, the program will only show the file of the first bank (.H00 or .B00).
  - When you select a file, if the extension is .HEX or .BIN the program will know that there is only one bank, while if it is .H00 or .B00 it will search for files with consecutive extensions until it does not find any more (maximum .H09 or .B09) and the number of files will be the number of banks recorded.
6. After all the data has been recognised, the program will begin the chosen operation.



- This process is divided in two parts, the first is erasing the flash memory and the second is the program recording.

7. When the recording program has finished communicating with the machine, a new window will appear showing the result of the process.

(For more information, consult the manual of the EASYFLASH reprogramming device)

### 5.7. Machine reset

The machine is factory configured with the initial values for product pushbutton panel, channel links and audits. If the technical support service considers it appropriate, the machine can be reset with all channels empty, in which case the following operation must be carried out.

With the main window on the display, press the programming button **P** for a few seconds, until you see the **MAIN MENU**.

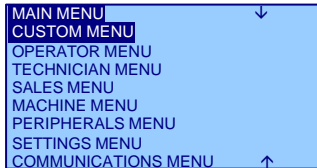

then you will see



Move with the programming button **P** to the option **MACHINE RESET** to accept the option press any product selection pushbutton **S** and the following menu will appear,



Move again using the programming button

**P** to the option **PRODUCTION RESET**.

To accept the option press any product selection pushbutton **S** and the following window will appear



**P** the display will now show



**P** and the screen will execute



at the end of the screen reset, the display will return to the **START-UP MENU**.

To return to the **MAIN MENU** press coin return **R**.

To exit the function repeatedly press the product selection pushbutton **C** to exit to the main window.

**Note:** This operation will configure all machine values back to factory settings.

 **VERY IMPORTANT:** This option is only for the technical support service.

## 5.8. Machine programming mode

### 5.8.1. Standby menu without credit (standby status)

This menu will be in standby status, shown on the display by rotating, in small intervals, the advertising message, the machine model, the time, the **JOFEMAR** web address. Press the product selection pushbutton panel and the display will show the price of the product .



#### Note:

If the machine is out of service, the cause will be shown on the display. In such cases, the machine does not accept any coin nor is any sale allowed. The machine may be out of service because no connected motor has been detected (this may be because no channel has been connected to the machine or because the channel to control card connection cable is not connected) or because of a fault in the product detection system.





### 5.8.2. Standby menu with credit (working status)

This menu is accessed by inserting credit and you can then select the product. If the credit inserted is insufficient the machine will indicate this on the display. In this menu you cannot change the values shown on the display.



### 5.8.3. Programming menu (programming status)

To enter and access the programming addresses, press  located inside the door when you enter this menu you can modify all the values of the machine's programming options.

To access the various programming addresses you can go up by pressing  or down by pressing , access the option by pressing  and go back by pressing . The order of the programming addresses is the same found in this manual.

#### ? Addresses shown by the display in descriptive mode (default) ?



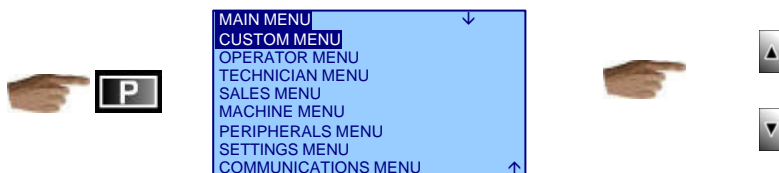





(To view all functions in numerical mode, press coin return )



**NOTE:** To modify the content of programming addresses, use the machine selection pushbuttons. These should be used in the order and in the way indicated below for each address.

Press...  
Pressing...



	Access to programming	
		Product selection / Go up an option ↑
		Product selection / Go down an option ↓
		Product selection / Accept/Enter the option
		Product selection / Cancel/Go back an option
		Product selection/ Move cursor to the right →
		Product selection/ Move cursor to the left ←



	Product selection / Number selection <b>(1,2,3,4,5,6,7,8,9,0)</b>
	Product selection
	Coin return

The machine can also exit programming mode automatically and return to standby without credit mode if about **2 minutes** elapse without any key being pressed or without any coin being inserted (in the case of tube reloading).

### 5.9. Programming addresses (Main Menu)



#### (207) CUSTOM MENU

This option allows machine owners to configure a Custom Menu so that those options they consider most useful appear faster



The first time and as long as it is not modified, the option will appear empty.



The Operator Menu has the following options:

#### (201) OPERATOR MENU



#### (003) MONEY ACCOUNTING

This option allows you to view the different audits that the machine records as money.





- MONEY ACCOUNTING
- TOTAL MONEY INSERTED
- MONEY TO VAULT
- MONEY TO TUBES
- MONEY IN BANKNOTES
- CREDIT IN TOKENS
- RETURNED CHANGE
- MONEY RELOADED
- MONEY DISCHARGED
- MONEY IN TUBES
- MONEY REVALUED IN CARD
- VALUE OVERPAYMENT MONEY
- VALUE TOKEN OVERPAYMENTS
- VALUE TOTAL SALES
- VALUE SALES MONEY
- VALUE OF SALES WITH CARD
- VALUE SALES WITH TOKENS
- VALUE SALES FREE MODE
- VALUE FREE SALES WITH CARD
- DESC. SALES WITH CARD
- OTHER DISCOUNTS
- VALUE TEST SALES
- VALUE SECOND OPTION SALES
- DELETE PARTIAL FIGURES

When you are in DELETE PARTIAL FIGURES



deletes the partial money audits.

**DELETE PARTIAL FIGURES**

In any other audit



displays the value of the selected audit

TOTAL:  
X.XX  
PARTIAL:  
X.XX



OPERATOR MENU

**(004) SALES PER PRODUCT SALES PER PRODUCT**

This option allows you to view the sales that the machine records for each programmed product.



allows you to see the following audits.



When you are in DELETE PARTIAL FIGURES



deletes the partial money audits.

**DELETE PARTIAL FIGURES**

In any other audit



displays the value of the selected audit

- SALES PER PRODUCT
- TOTAL SALES
- SALES WITH MONEY
- SALES WITH CARD
- SALES WITH TOKENS
- SALES IN FREE MODE
- SALES FREE WITH CARD
- TEST SALES
- LOST SALES OUT OF CHANGE
- LOST SALES OUT OF PRODUCT
- DELETE PARTIAL FIGURES

- 1-> T: X P: X
- 2-> T: X P: X
- 3-> T: X P: X
- 4-> T: X P: X
- 5-> T: X P: X





OPERATOR MENU  
SALES BY MACHINE

**(018) SALES BY MACHINE**

In this option you can view the same audits as in the previous option accounted by machine.



allows you to see the following audits.

- SALES BY MACHINE
- TOTAL SALES
- SALES WITH MONEY
- SALES WITH CARD
- SALES WITH TOKENS
- SALES IN FREE MODE
- SALES FREE WITH CARD
- TEST SALES
- LOST SALES OUT OF CHANGE
- LOST SALES OUT OF PRODUCT
- DELETE PARTIAL FIGURES

When you are in DELETE PARTIAL FIGURES deletes the partial money audits.

DELETE PARTIAL FIGURES

In any other audit displays the value of the selected audit

TOTAL:  
X.XX  
PARTIAL:  
X.XX



OPERATOR MENU  
TUBE RELOADING

**(015) TUBE RELOADING**

In this option the coin changer tubes are reloaded, counting the coins in the relevant audit.

displays

INSERT COINS

With each coin that is inserted the display shows the value of the coin and all the coins of that value in that tube.





OPERATOR MENU

**(016) TUBE DISCHARGING** TUBE DISCHARGING

In this option you can discharge the coin changer tubes.



displays the following

TUBE 1 1.00  
NO. COINS XX

This indicates the value of the coin that goes to tubes and the number of coins that have currently been audited.



selects the value of the coin that you wish to discharge



begins discharging.

TUBE 2 0.05  
NO. COINS X

TUBE 3 0.10  
NO. COINS X

TUBE 4 0.50  
NO. COINS X

TUBE 5 2.00  
NO. COINS X

ONE COIN FROM  
EACH TUBE



OPERATOR MENU

**(050) MACHINE ID NUMBER** MACHINE ID NUMBER

In this option you program the machine ID number.



displays the current number

MACHINE ID NO.  
000000



MACHINE ID NO.  
--

You can program a 6-digit number to be used on printer tickets, audits, communications etc. as machine identification.



MACHINE ID NO.  
258---

using numerical selection.

After the 6 digits are accepted the new ID number is recorded in the machine memory.

If at any time



you exit to the previous menu without recording the number.



OPERATOR MENU

**(049) PRODUCT CODES** PRODUCT CODES

In this option you program the product ID codes. These codes are used in the audit tickets, communications via modem or terminal.



displays

PRESS SELECTION  
--

In this situation the machine waits for the user to press the relevant selection, if you wish to cancel at this point





**S** displays the following . The “X” represents the number of active product inside the machine (see the key/channel linking options).

Displays

To be able to program the product ID number of the same way as the machine's.

If at any time **C** cancels the selection.

**R** returns to the previous option.

**C** returns to the **MAIN MENU**.



In the technician menu you will find the following options:

**(200) TECHNICIAN MENU**



**(056) PROGRAM VERSION**

**A**

**C**



**(024) EVENT LOG REVIEW**

This option serves to visually review the machine activity.

**A** enters the option and displays the last stored event

moves from one event to the next, finishing with

**To be able to interpret the log, see the document “event log”.**

**C**



**(026) CUSTOM MENU add OPTIONS**

This option allows you to add options to the custom menu. Follow the procedure below.



the following menu is displayed 
  
 to switch between the options
   
 to access the chosen function.

If you are in the function **ADD NEW**

takes you to the window you return to
   
 the screen then displays

Move to **SEARCH OPTION**

using and calls up the menu

make your selection with and

to include the option that you wish and record it.

When you are in the option **DELETE POSITION**

and to move to in the option to be deleted 
  
 and removes it from the menu.

When you are in **RECORD MENU**

executes 
  
 returns to a previous position.
   
 exits to the previous menu.

**(022) PASSWORD MAINTENANCE**

The machine has 4 different passwords to protect the access to the different options. In this option se the numbers to be entered to enable the passwords are created.



A displays

to select the password that you wish to modify from 1 to 4.

A displays the current password

A allows you to modify the 4 digit numerical password

N using numerical selection.

C exits to the previous menu and changes the password.

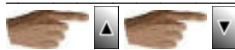

**(023) PASSWORDS DE THE OPTIONS**

This option allows you to indicate which options are going to require entering a password to be able to access it. This option always appears but if it is protected, when you try to access it, the machine requests the access password. If you do not enter it correctly, you cannot access the option. If you are going to work with passwords, do not forget to protect this option and the previous one with an access password so one cannot consult the password.

A displays on screen

moves between passwords from 1 to 4.

A selects the option to be modified and displays the following screen

C exits to the previous menu and changes the password, “X” is the option number selected “Y” is the password number. Shows whether the password is active or inactive for that option.

to modify it

A records the selection. When the password is active for that option this means that it has to be entered to be able to enter the option. Once you have entered the password, it is not necessary to enter it again while you remain in programming mode.

C returns to the previous menu.





**(254) OPTION DEBUGGING** TECHNICIAN MENU  
OPTION DEBUGGING

This option allows you to debug all the options.

A shows the first option. Vd\_MaxOverRunnin  
0

moves between options from 0 to 13.

C

In the sales menu you will find the following options:

**(202) SALES MENU** MAIN MENU  
SALES MENU A

**(006) TYPE OF SALE** SALES MENU  
TYPE OF SALE

A displays the type of sale currently selected.

moves the different possibilities and A records the chosen selection.

The possible options are as follows.

**TYPE OF SALE**

FREE

**SINGLE**

SINGLE MIXED 1

SINGLE MIXED 2

MULTIPLE

C exits programming.

**(001) MONEY SALES PRICES** SALES MENU  
MONEY SALES PRICES

A displays MODIFICATION  
PRICES

changes to REVIEW  
PRICES

When you are in **REVIEW PRICES**

A enters the screen PRESS SELECTION  
---



 **S** displays the following message for a few seconds

 **PRODUCT Y**  
**PRICE X.XX**

Where “Y” is the active product of that selection (see key/channel linking programming option” and “X.XX” is the current price of that product.

 **R** exits that state.

When you are in **MODIFICATION PRICES**

 **A** displays the following screen  **PRICE:**  
---

In this screen you should select with  **N** until you reach the price that you wish to program and  **A**.

Above the last digit, you will see the following screen  **PRICE X.XX**  
**SELECTION: ---**

Where “X.XX” is the price that you have programmed.  **S** for the selections that you wish to work with that price to assign it to the product.

When you have finished assigning prices,  **R** to program another price.

If you do not need to program another price  **C** to exit this state.

 **C**

 **▲**  **▼**

 **SALES MENU**  
**PRICES SALES WITH CARD**

### (002) PRICES SALES WITH CARD

This option is handled just like the previous one for the prices that the machine applies when there is a card inserted.

 **C**



 **▲**  **▼**

 **SALES MENU**  
**RETURN OPTION PROGRAMMING**

### (009) RETURN OPTION PROGRAMMING

In this option you program whether the machine will allow money to be returned if there has been no purchase or if it is going to force a purchase before returning money. Remember that if the product requested by the customer is not available the machine must allow returns.

 **A** displays the current option.

 **▲**  **▼** changes through the different possibilities and  **A** records the displayed selection.

The possible options are as follows.

RETURN ALLOWED  
ALWAYS  
AFTER THE SALE



SALES MENU  
MAXIMUM ACCEPTANCE

**(020) MAXIMUM ACCEPTANCE**

This allows you to limit the value that the machine is going to accept. Currently the machines must accept money above the maximum price to allow reloading of the change tubes. This value is what limits this action.



displays the maximum acceptance currently programmed

MAX. ACCEPTANCE  
150.00



a second time allows you to modify this value

MAX. ACCEPTANCE  
---



using numerical selection, records the amount on the last digit or



accepts and records the amount.



no records nada and sale de the action.



SALES MENU  
MAXIMUM RETURN

**(021) MAXIMUM RETURN**

This is the highest return that the machine is going to return after a sale. In machines with significant disparity in prices, this may be advisable so the machine is not used as a change dispenser.

**? This option is handled just like the previous one.**



In the machine menu you will find the following options:

MAIN MENU  
MACHINE MENU

**(203) MACHINE MENU**



MACHINE MENU  
DISPENSER STATUS

**(066) DISPENSER STATUS**



**A** displays the following two options

While you have selected **STATUS DISPLAY**

**A** displays the following that is, the state of the first dispenser of the machine.

to select the different dispensers in the machine.

The possible states are as follows:

- 
- 
- 

While you have selected **RESET FAULTS**

**A** displays the following

At the end of the process, it returns to the previous menu.

---

**(064) KEY/CHANNEL LINKS**

**A** takes you to the next window

When you are in **REVIEW CONFIGURATION**

**A** displays the following when you

**S** the following will be displayed

Where “Z” is the number of active product, “PXX” is the button linked to that product (there can be more than one) and “MY Y” is the motor (there can be more than one).

By progressively **S** you can review all the products.



To finish with this window, **R**

When you are in **MODIFICATION OF CONFIGURATION**

**A** displays the following when you

**S** the following will be displayed in this window you

have to go **S** that you wish to be assigned to this product and the product microswitches of the dispensers that you wish to link to that product.

To finish the group **R** and you can select another active product.

**R** returns to the previous menu.

When you are in **NEW CONFIGURATION**

**A** displays the following

**C**

When you are in **NEW PRODUCT**

**A** displays the following when you

**S** the following will be displayed

**R** returns to the previous menu.

**C**

**▲** **▼**

**(065) MANUAL HANDLING**

Checks the state de all the dispensers that you select.

**A** displays the first dispenser by default

**▲** **▼** moves through all the dispensers in the machine.

**A** carries out a check of the state of the dispenser.

**C**

**▲** **▼**

**(047) BLOCKING OF MINORS** MACHINE MENU  
BLOCKING OF MINORS

It blocks minor access to comply with local regulations.

 A displays the following menu

BLOCKING OF MINORS  
TOKEN DISABLED  
REMOTE CTRL. TEMPORARILY DISABLED



When you are in **TOKEN DISABLED**

 A displays

TOKEN  
VAULT  
RETURN  
DISABLED

  to choose an option

 A records that option and exits to the previous menu.

When you are in **REMOTE CONTROL DISABLED**

 A displays

REMOTE CONTROL  
SINGLE  
MULTIPLE  
DISABLED

  to choose an option

 A records that option and exits to the previous menu.



**(104) KEY CODE** MACHINE MENU  
KEY CODE

Using a code entered through the product selection panel, you can obtain a physical key to open the machine for inspection purposes.

 A displays the following menu

KEY CODE  
VIEW CODE  
CHANGE CODE







When you are in **VIEW CODE**

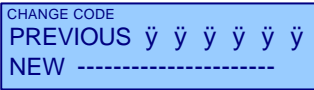

 A displays the existing code

VIEW CODE  
y y y y y y





When you are in **CHANGE CODE**



 **A** displays   **N** changes the code with the numerical keypad.

 **A** records the new code and exits to the previous menu.  
 **C**



**(103) RESET FAULTS**  
 Resets the possible faults of the X10 compact





 **A** displays the following menu   **A**  



executes the action   
 at the end of the process the following is displayed  **C**

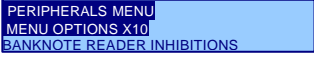



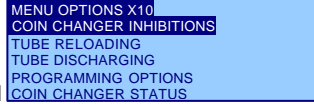

**In the peripherals menu you will find the following options:**

**(204) PERIPHERALS MENU**   **A**

Displays a submenu with the following options   
   
 **C**

**(209) MENU OPTIONS X10**   

 **A** and the following menu will be displayed  
   
 **C**



**(014) COIN CHANGER INHIBITIONS**

MENU OPTIONS X10  
COIN CHANGER INHIBITIONS

Serves to see and modify the admission status of the different coins.

**A** displays the “display” where “X.XX €” is the value of the coin.

displays the status of the different coins

COIN: X.XY  
ACCEPTED

When you wish to modify the status of one of them **A** and the display will switch to

The “**M**” in the second line indicates that the status is going to be modified.

goes from **ACCEPTED** to **DISABLED**.

**A** records the new status.

**C** exits without recording it.

**C**

MENU OPTIONS X10  
TUBE RELOADING

**(015) TUBE RELOADING**

**A** TUBE RELOADING

? See operator menu.

**C**

MENU OPTIONS X10  
TUBE DISCHARGING

**(016) TUBE DISCHARGING**

**A** TUBE DISCHARGING

? See operator menu.

**C**

MENU OPTIONS X10  
PROGRAMMING OPTIONS

**(039) PROGRAMMING OPTIONS**

This function allows you to change the amount of coins that end up in each tube of the coin changer or its coin limit.



When you are in **COINS TO TUBES**



switches from the first tube that appears by default to the next one.

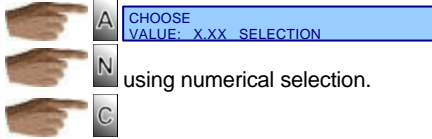

changes the value of the coins,

using numerical selection.

When you are in **TUBE LIMITS**

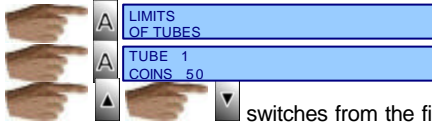

switches from the first tube that appears by default to the next one.

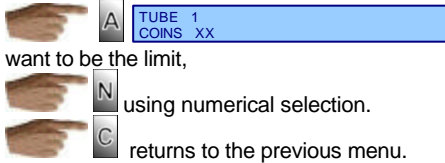

changes the amount of coins that you want to be the limit,

using numerical selection.

returns to the previous menu.



**(041) COIN CHANGER STATUS**

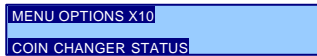

This serves to find out the load status of the coin changer and to load it.

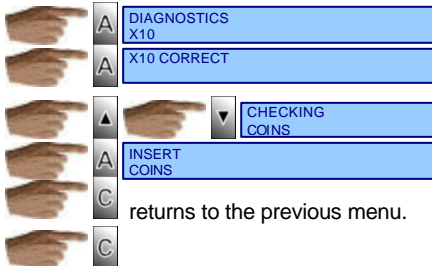





returns to the previous menu.



**(017) BANKNOTE READER INHIBITIONS**

PERIPHERALS MENU  
BANKNOTE READER INHIBITIONS

It works the same way as function (014) coin changer inhibitions.

  returns to the previous menu.  
 

The settings menu offers the following options:



**(205) SETTINGS MENU**





MAIN MENU  
SETTINGS MENU  

**(007) DATE AND TIME SET**

SETTINGS MENU  
DATE AND TIME SET

  displays the following 

    passes from time to date 

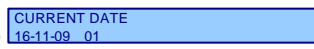
  allows you to modify both the time and the date.

The “01” on the right indicates the day of the week.

    modifies the digit

    moves the position in the digit

Once the screen has been set   records the values.

  exits without recording changes.

**(043) CLOCK MODE 12/24 HOURS**

SETTINGS MENU  
CLOCK MODE 12/24 HOURS

You can program the appearance of the clock when the machine is in standby between 12 and 24 hours.

  displays the current configuration 

    changes the configuration.

To record the new configuration  



**C** to exit without changes. This option modifies the appearance of the clock on standby, when you are programming the clock it is always displayed in 24 hours format to avoid errors.



SETTINGS MENU  
MESSAGE PROGRAMMING

**(013) MESSAGE PROGRAMMING**

In this address you can program a message of up to 54 characters that cycles in marquee fashion when the machine is in standby.

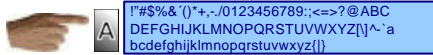

accesses the descriptive text screen.

With the first letter highlighted by the cursor.

To switch between digits right or left.

selects the character.

Once the complete text has been selected search the display using



accepts and records the message.

exits and records the data.



SETTINGS MENU  
BEEP PROGRAMMING

**(010) BEEP PROGRAMMING**

In this option you program whether the beep should be heard when a key is pressed during programming or during a sale.



changes de option.

records the modified data.

exits to the main window.





SETTINGS MENU  
NUMBER OF DECIMAL PLACES

**(008) NUMBER OF DECIMAL PLACES**

With this option you can program the number of decimal places employed by the machine. To work in € mode program 2 decimal places. There are 6 programming possibilities.

NO. DECIMAL PLACES:  
↓  
0 DECIMAL PLACES  
1 DECIMAL PLACE  
2 DECIMAL PLACES  
3 DECIMAL PLACES  
COIN CHANGER  
BANKNOTE READER

shows the current status  
 to select one option or the other.

In the option **COIN CHANGER** (uses the decimal places sent by the coin changer).

In the option **BANKNOTE READER** (uses the sent by the banknote reader).

In the option **CARD READER** (uses the sent by the card reader).

records the modified data.  
 exits to the main window.



SETTINGS MENU  
CURRENCY PROGRAMMING

**(012) CURRENCY PROGRAMMING**

In this option you can program the symbols or texts that accompany money displays. When you use the symbols “\$” or “&” they are placed in front of the figure. When you use the symbol “€” it is placed after the figure.

displays the currently programmed currency unit

CURRENCY UNIT:

`!"#$%&()*+,-./0123456789:;<=>?@ABC  
DEFGHIJKLMNOPQRSTUVWXYZ[ ]^_`a  
bcdefghijklmnopqrstuvwxyz{|}` accesses the descriptive text screen.

With the first letter highlighted by the cursor.

To switch between digits right or left.

records the letter or symbol selected as currency unit. The maximum number of characters is 3.

Once you have selected the symbol search the display using

END or RETURN

accepts and records the message.



exits and records the data.

**(027) LANGUAGE CONFIGURATION**

In this option you can choose the interface language from available ones.

displays the current machine interface language

to switch between languages.

modifies the machine interface language.

sale without modify the language.

Each application has a different language set.

returns to the previous menu.

In the communications menu, the following options are available:

**(206) COMMUNICATIONS MENU**

**(057) PRINT TICKET**

If there is a printer connected, it will print a ticket with all the carried out by the machine, from the data that you enter.

**(058) PRINTER BEHAVIOUR**

This detects the behaviour of the printer that has been previously connected.

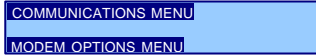

(213) MODEM OPTIONS MENU

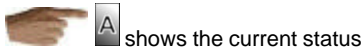
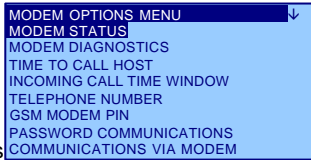

To select one option or the other



When you are in **MODEM STATUS**



When you are in **MODEM DIAGNOSTICS**



When you are in **TIME TO CALL HOST**

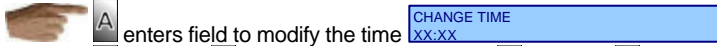
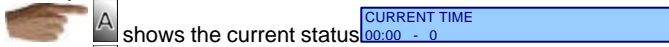

the digit accepts the change.

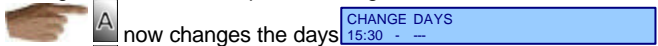

using numerical selection.

accepts the changes and returns to the menu.

When you are in **INCOMING CALL TIME WINDOW**

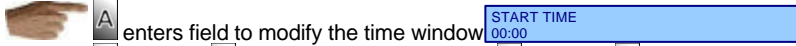
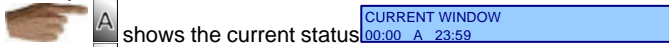

the digit accepts the change.



**A** now changes the end time .  
 modifies the digit moves the position in the digit **A** accepts the change.

**C** records the change and accepts returning to the previous menu.

When you are in **TELEPHONE NUMBER**

**A** shows the current status .  
**A** changes the telephone number .  
 modifies the digit moves the position in the digit **A** accepts the change.

**C** records the change and accepts returning to the previous menu.

When you are in **PIN OF THE MODEM GSM**

**A** shows the current status .  
**A** enters field to modify the time .  
**N** using numerical selection.  
**A** accepts the changes and returns to the previous menu.

When you are in **COMMUNICATIONS PASSWORD**

**A** shows the current status .  
 goes from one screen to the next

**A** allows you to modify the two options.  
**N** using numerical selection.  
**A** accepts the changes.

When you are in **COMMUNICATIONS VIA MODEM**

**A** shows the current status

**A**   
 At the end of the process it will exit to the main window.  
**C**



## 6. Troubleshooting

The following table will help you diagnose the most common machine and coin changer failures. It describes a series of anomalies, their possible causes and the steps to take in solving them or in determining the cause of such failures before contacting our customer service.

FAULT	CAUSE	SOLUTION
<p>? No sales from a channel with product.</p>	<p>? Channel as faulty, keypad fault.</p> <p>? Insufficient change.</p>	<p>? Check that the out of product message appears or that the product price appears when you press the key and the machine has no credit. If the price does not appear, it means that the keypad is not working properly.</p> <p>? If you get an out of product message, check the fault. If there is a fault, reset.</p> <p>? Check that when you select the product the display shows an out of change message and try using exact price.</p>
<p>? No price appears on the display When you press some keys some slides with product appear as empty.</p>	<p>? The machine is not properly configured.</p>	<p>? Check that the right machine type appears. If it is incorrect, program the right machine type.</p>
<p>? Nothing appears on the display, the external coin return tube does not respond.</p>	<p>? Jofemar communications cables are incorrectly connected.</p>	<p>? Connect them properly.</p>
<p>? Coins are not accepted. You cannot enter coin reloading mode.</p>	<p>? The machine does not respond to communications properly.</p> <p>? The compact has no power supply or the wrong power supply.</p>	<p>? Check that the supply voltage is within the range admitted by the device.</p> <p>? Check continuity of cables between the machine and the compact.</p>
<p>? You can enter programming mode but the</p>	<p>? Cables are incorrectly connected.</p>	<p>? Connect them properly.</p>



compact does not communicate.		
? The compact communicates properly and you can enter programming mode but all coins are rejected.	? The selector does not accept the coins.  ? The machine coin acceptance channel is touching the selector antistring device.	? Check coin acceptance  ? Lift selector switch no. 8 and check whether the coin is accepted.
The compact communicates properly and you can enter programming mode but no coin is accepted.	? Prices not programmed	? Program prices .
? The compact sends all coins to the vault.	? Change is incorrectly programmed.  ? The change tubes are faulty.  ? Maximum values programmed for coins in the tube have been exceeded.	? Check coin values.  ? Check where the coins are being sent.  ? Reset the fault and empty the tubes.  ? Check the maximum number of coins that can be in tubes.
? Coins get stuck at the entrance of the tubes.	? Change is incorrectly programmed.  ? Separators are sticking.  ? Wrong tube model for this change combination.	? Review values.  ? Send the X-10 to technical support service. Replace the tubes.
? The compact rejects a high percentage of coins. In coin check, the coins appear as unrecognised.	? Measuring channel is dirty.  ? The selector door is not completely closed.	? Clean the selector with a cloth moistened with alcohol. If the problem continues, send the selector to customer service for adjustment.  ? Check coin return lever is working properly. Get rid of any other obstruction.



? The compact does not accept any coin.	? The connection cable between the selector and the control card is broken or disconnected.	? Connect the cable.
? Programmed data has been lost.	? Electric noise.	? Make sure the machine is properly grounded.
? When reloading coins, coins are not accepted from tubes.	? First reloading was not carried out properly.	? Consult first reloading procedure in compact manual.
? Coins with a given value are not accepted.	? Inhibitions wrongly programmed or return failure.	? Check general inhibitions.  ? Make sure change tubes have coins and are working properly.
? All coins are rejected. No sale is possible and the display shows a message saying the machine is out of service.	? Machine out of service because of fault or because there is no motor connected.	? Check the fault.  ? If there is a fault, reset.  ? If no motor is connected, check channel connections.
? No banknotes accepted.	? Insufficient change.  ? The banknote has been inhibited.  ? Banknote not recognised by banknote reader.	? Check whether when the banknote is rejected there is an out of change message on the display.  ? Check banknote inhibitions.  ? Check banknote acceptance.
? You can not communicate with the machine from the PC via modem.	? Incorrect modem options programming.  ? Incorrect connection between machine and modem interface card. The result is that the modem addresses do not appear.  ? The program recorded in the Flash memory of the machine control card is not the right one.	? Check the modem's addresses or reset the machine to initialise the modem's options.  ? Check connection.  ? Check program version and if it is the wrong one, load the right program version.

## 7. Annexes

### 7.1. Transport feet and adjustable levelling feet

Once the machine is on the ground, it is advisable to remove the two (metal) transport feet.

1. Raise one side and remove the two screws visible on the side of the cabinet and remove the transport foot from the back. Proceed likewise with the other side.

2. Slide the machine on its casters to the desired position. Once the machine has been placed in its permanent position, raise the front again and level the machine using the adjustable levelling feet. With this system you can help to level the door perfectly, thereby preventing scraping it.



Fig. 28

### 7.2. Removing the product outlet collector

If the control card requires servicing or modifying, you need to remove the collector from the cabinet. Pay particular attention when removing this part, as you can easily scratch or break the side harnesses. To do this, follow these steps:

1. Get a Phillips screwdriver and open the machine door.
2. Open the compact support .
- 3 Remove the two anchoring screws on the product outlet collector.
4. To remove the product outlet collector more easily, tilt it slightly towards the right and then pull outwards.

### 7.3. Vandal protection (Optional)





You can program a vandal protection system in the machine that will make the machine behave differently as soon as a product is detected.









There are different security systems available:





- ? **Switch on outside door with GSM modem.**
- ? **Label seal**
- ? **Programmable LED lighting.**





### 7.4. Minor remote control configuration

To configure or delete one or more (up to 80) remote controls in the memory of the card (located behind the door grills), follow the steps pictured below:

A. ADD A REMOTE CONTROL				
				
Press the button on the card for <b>4 seconds</b>	The LED on the card will show <b>1 pulse</b> Now the card LED is <b>off</b> <b>?</b>	<b>Press</b> the pushbutton of the remote to be configured	The LED on the card will show <b>1 pulse</b>	The card and remote are now <b>linked</b>

B. ADD SEVERAL REMOTE CONTROLS						
					 	
Press the button on the card for <b>4 seconds</b>	The LED on the card will show <b>1 pulse</b> Now the card LED is <b>off</b> <b>?</b>	<b>Press</b> the pushbutton of the remote to be configured	The LED on the card will show <b>1 pulse</b>	<b>Repeat</b> the previous operation for all the remotes to be added (maximum 80)	If you are not going to configure any more remotes, stop pressing remotes and/or cards The LED on the card will show <b>1 pulse</b>  to close the programming cycle	The card and remotes are now <b>linked</b>

C. DELETING A REMOTE FROM CARD MEMORY				
				
Press the button on the card for <b>4 seconds</b>	The LED on the card will show <b>1 pulse</b> Now the card LED is <b>off</b> <b>?</b>	<b>Press</b> the pushbutton of the remote to be configured	The LED on the card will show <b>1 pulse</b>	The remote has now been <b>deleted</b> from the card memory

D. DELETING ALL REMOTE CONTROLS FROM CARD MEMORY				
				
Press the button on the card for <b>4 seconds</b>	<b>Release</b> the card button	Press the button on the card again for <b>4 seconds</b>	The LED on the card will show <b>3 long pulses</b>	All remotes have now been <b>deleted</b> from the card memory

## 7.5. Peripherals

### External coin return tubes (Optional)

The machine is ready to admit an external coin return tubes kit on a support ins the cabinet. This provides a greater amount of coins for returns.

To cater to the needs of each owner, these machines (depending on configuration) can fit up to 8 external coin return tubes for different types of coins.



Fig. 29

### Banknote reader (Optional)

? The banknote reader consists of a reading head that reads the banknote and validates it against a set of patterns it has stored in memory. Should the banknote be recognised, it is sent to a stacker used for storing the banknotes (capacity / 500).

? The front cover of the banknote reader has several status LEDs, green and red, which show the reader's activity at all times as well as possible faults.

? Banknote readers using the **X10** communications protocol can only be used if the program version is for working with the compact **X10**.

? (See banknote reader manual.)



Fig. 30

### Key and card reader (Optional)

- **JOFEMAR** Card Reader. It can be used for purchases with cards (normal or free), to recharge cards with credit, to program the machine and to get audits. Communications with the card reader take place via RS-232. When working with an

X10 coin changer, the card reader is connected to one of the two RS-232 ports on the machine control card.



Fig. 31

- The **X10** card reader, with which we can only make sales with cards, can be used if the program version is for working with the compact **X10**.
- (See card reader manual.)

### MODEM kit (Optional)

? Line or GSM modem with modem interface card (ref. code 8590049). Available if the program version is for working with an MDB compact.

? (See modem communications interface card manual.)



Fig. 32

### MODEM COMMUNICATIONS INTERFACE CARD

<b>A.</b> MODEM connection
<b>B.</b> Input/output power supply, communications protocol 485
<b>C.</b> Input/output power supply, communications protocol 485
<b>D.</b> Battery charger
<b>E.</b> MODEM power supply
<b>F.</b> (Not in use)



Fig. 33

### EASYFLASH reprogramming device (Optional)

? The main function of the “EASYFLASH” reprogramming device is to run applications that help manage the Jofemar product range. It is thus an independent, compact, manageable instrument that allows the user to carry out tasks such as reprogramming the software of the machines, reading audits, monitoring processes, storing information, etc.

It is accessible through a USB bus, so modern operating systems (starting with Windows XP) do not require installing drivers to access its file system. All you have to do is connect it to a USB port for the operating system to recognize it.

Thanks to the use of batteries, it is very compact and easy to manage. To charge the batteries, no external charger is required and the batteries are recharged when the unit is connected to a USB port or to a vending machine that is on.

It has an application called **Monitor**, which is basically an operating system. The Monitor allows you to control available resources. In addition to the Monitor there are Applications, which are programs that are run in the device that use resources to carry out certain functions.



**Fig. 34**

The Monitor allows you to load up to 4 applications in the main memory from among those available in the SD memory card.

You can determine the version that is currently running in your device by looking at the top of all the windows of the main menu of the Monitor. The format is vXX.YY. A correct version should have the value 00 for YY. If this is not the case, please contact Jofemar Technical Support Service to obtain a stable version.

It comes with the following cables so it can be used with the full range of **Jofemar** devices:



USB Device harness SUBD-9/Selector

**Fig. 35**

(See the EASYFLASH reprogramming device manual)



USB Device harness MDB/RS485/DIN 5 pin

**Fig. 36**



USB cable

**Fig. 37**

### Key dispenser (Optional)

This component is installed at the base of the cabinet, fixed in place with two screws on the base and another half way up the cabinet.

Its function is to dispense a key for inspection services or for the operation owner by entering a code. The key comes out of the lower opening in the door.



**Fig. 38**

## 8. Cleaning and Maintenance

### Cleaning the machine.

To ensure the machine works properly at all times, we recommend that the following components be cleaned periodically:

- ? Do not clean the machine with a water jet.
- ? The advertising panel should be cleaned periodically with a moist cloth or sponge and a suitable neutral product.
- ? If there is a spill on a channel, remove the channel from the machine and clean it using a cloth moistened with water, never with alcohol or acids. Wait until it is completely dry before replacing it.
- ? The whole interior of the machine should remain dry at all times to ensure it works properly.
- ? It is very important never to touch those areas powered at 220 V, such as the ballast box, the power box and live cables. To access areas where there are components powered at 220 V, open the machine's outside door and use a Philips screw driver to remove the metal boxes protecting these components.
- ? Access to servicing area should only be permitted to persons with a knowledge of and practical experience in the machine, particularly with regard to health and safety.
- v? To clean the exterior of the machine, use a moist cloth with warm water and dry with a soft cloth.
- v? In case of persistent stains (grease, drinks, etc.), do not apply abrasive products. Do not use a cleaning sprays! Use a solution of water and alcohol.
- ? In general, keeping all internal areas that are visible to consumers clean increases sales and improves the image of the machines.

### Cleaning the selector

The walls and ramps of the coin selector where coins circulate should be cleaned regularly (see fig. 39) with a soft brush and a moist cloth.



Fig. 39

## 9. Recycling



When you need

to discard packing materials, please find out about how they can be recycled.



Do not dispose of electronic circuits as domestic waste as many of the materials used to manufacture its components are recyclable.

To manage the equipment as waste once the client has decided to dispose of it,



**Jofemar S.A.**

reserves the right to introduce  
improvements in this model arising from  
its continuous research without prior  
notice



[http:// www.jofemar.com](http://www.jofemar.com)